



FEATURES

Powered for Continuous Operation: All ratings are within the working limits of the motor as recommended by the motor manufacturer. Pump can be operated continuously without damage to the motor.

Field Serviceable: Units have left hand threads and are field serviceable with common tools and readily available repair parts.

Sand Handling Design: Our face clearance, floating impeller stack has proven itself for over 50 years as a superior sand handling, durable pump design.

FDA Compliant Non-Metallic Parts: Impellers, diffusers and bearing spiders are constructed of glass filled engineered composites. They are corrosion resistant and non-toxic.

Discharge Head/Check Valve: Cast 303 stainless steel for strength and durability. Two cast-in safety line loops for installer convenience. The built-in check valve is constructed of stainless steel and FDA compliant BUNA rubber for abrasion resistance and quiet operation.

Motor Adapter: Cast 303 stainless steel for rigid, accurate alignment of pump and motor. Easy access to motor mounting nuts using standard open end wrench.

Stainless Steel Casing: Polished stainless steel is strong and corrosion resistant.

Hex Shaft Design: Six sided shafts for positive impeller drive.

Engineered Polymer Bearings: The proprietary, engineered polymer bearing material is strong and resistant to abrasion and wear. The enclosed upper bearing is mounted in a durable Noryl® bearing spider for excellent abrasion resistance.

5GS, 7GS, 10GS, 13GS, 18GS & 25GS

5-25 GPM, ½ - 5 HP, 60 HZ, SUBMERSIBLE PUMPS

WATER END DATA

Series	Model	Required HP	Stages	Length (in)	Weight (lbs)
5GS	5GS05R	.5	9	12.9	8
	5GS05	.5	12	15.0	9
	5GS07	.75	15	17.0	11
	5GS10	1	20	21.7	13
	5GS15	1.5	26	25.8	15
	5GS20	2	33	31.6	19
7GS	7GS05R	.5	7	11.7	6
	7GS05	.5	10	13.8	7
	7GS07	.75	13	16.0	8
	7GS10	1	17	18.8	9
	7GS15	1.5	22	23.6	12
	7GS20	2	27	27.2	13
10GS	10GS05R	.5	5	10.1	6
	10GS05	.5	7	11.5	7
	10GS07	.75	10	13.6	8
	10GS10	1	12	15.0	9
	10GS15	1.5	17	18.4	12
	10GS20	2	20	21.7	13
	10GS30	3	27	27.5	18
	10GS50R	5	35	33.0	21
	10GS50	5	42	40.2	24
13GS	13GS05	.5	5	10.1	6
	13GS07	.75	7	11.5	7
	13GS10	1	10	13.6	8
	13GS15	1.5	12	15.0	9
	13GS20	2	17	18.4	12
	13GS30	3	21	22.3	15
18GS	18GS07	.75	6	11.8	7
	18GS10	1	8	13.5	8
	18GS15	1.5	11	16.1	10
	18GS20	2	14	18.6	11
	18GS30	3	19	24.1	15
	18GS50R	5	24	28.3	17
	18GS50	5	30	34.4	21
25GS	25GS10	1	7	13.4	8
	25GS15	1.5	9	15.3	9
	25GS20	2	11	17.2	10
	25GS30	3	15	20.9	14
	25GS50R	5	22	28.7	17
	25GS50	5	26	33.4	21

NOMENCLATURE See price book for complete order numbers.

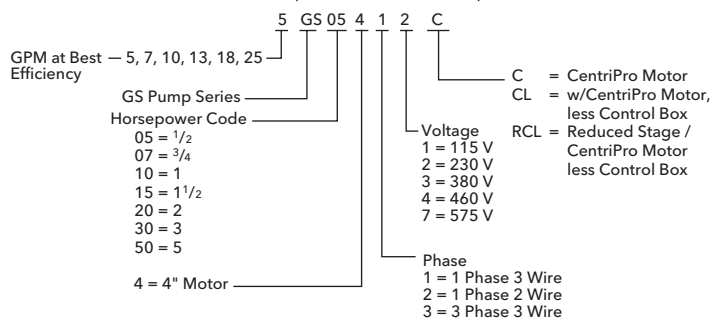

"GS" SERIES MATERIALS OF CONSTRUCTION

Part Name	Material
Discharge Head	AISI 303 SS
Check Valve Poppet	AISI 304 SS
Check Valve Seal	BUNA, FDA compliant
Check Valve Seat	AISI 304 SS
Check Valve Retaining Ring	AISI 302 SS
Bearing Spider - Upper	Noryl® GFN2
Bearing	Proprietary Engineered Polymer
Klipring	AISI 301 SS
Diffuser	Lexan®
Impeller	Noryl®
Bowl	AISI 304 SS
Intermediate Sleeve *	AISI 304 SS, Powder Metal
Intermediate Shaft Coupling *	AISI 304 SS, Powder Metal
Intermediate Bearing Spider *	Glass Filled Engineered Composite
Intermediate Bearing Spider *	AISI 303 SS
Shim	AISI 304 SS
Screws - Cable Guard	AISI 304 SS
Motor Adapter	AISI 303 SS
Casing	AISI 304 SS
Shaft	AISI 304 SS
Coupling	AISI 304 SS, Powder Metal
Cable Guard	AISI 304 SS
Suction Screen	AISI 304 SS

*See repair parts for where used.

SPECIFICATIONS

Model	Flow Range GPM	Horsepower Range	Best Efficiency GPM	Discharge Connection	Minimum Well Size	Rotation ^①
5GS	1.2 - 7.5	1/2 - 2	5	1 1/4"	4"	CCW
7GS	1.5 - 10	1/2 - 3	7	1 1/4"	4"	CCW
10GS	3 - 16	1/2 - 5	10	1 1/4"	4"	CCW
13GS	4 - 20	1/2 - 3	13	1 1/4"	4"	CCW
18GS	6 - 28	3/4 - 5	18	1 1/4"	4"	CCW
25GS	8 - 33	1 - 5	25	1 1/4"	4"	CCW

① Rotation is counterclockwise when observed from pump discharge end.

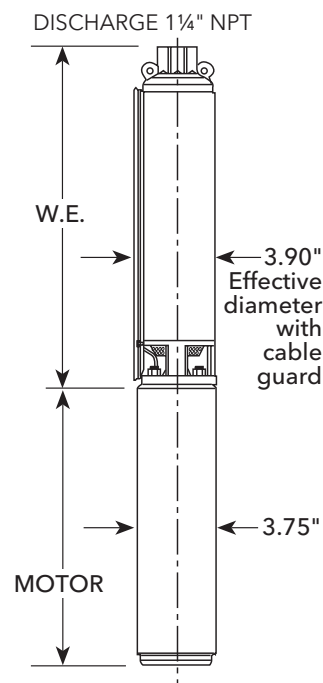

CENTRIPRO 4" SINGLE-PHASE MOTORS

Order No.	Type	HP	Volts	Length in. (mm)	Weight lb. (kg.)
M05421	2-wire PSC	½	115	11.0 (279)	20 (9.1)
M05422		½		11.0 (279)	20 (9.1)
M07422		¾	230	12.4 (314)	23 (10.4)
M10422		1		13.3 (337)	25 (11.3)
M15422		1.5		14.9 (378)	29 (13.2)
M05411	3-wire	½	115	10.0 (253)	19 (8.6)
M05412		½		9.7 (246)	18 (8.2)
M07412		¾	230	10.8 (275)	22 (10)
M10412		1		11.7 (297)	23 (10.4)
M15412		1.5		13.6 (345)	28 (12.7)
M20412		2		15.1 (383)	31 (14.1)
M30412		3		18.3 (466)	40 (18.1)
M50412	5	27.7 (703)	70 (31.8)		

NEMA MOTOR

- Corrosion resistant stainless steel construction.
- Built-in surge arrestor is provided on single phase motors through 5 HP.
- Stainless steel splined shaft.
- Hermetically sealed windings.
- Replaceable motor lead assembly.
- NEMA mounting dimensions.
- Control box is required with 3 wire single phase units.
- Three phase units require a magnetic starter with three leg Class 10 overload protection.

CENTRIPRO 4" THREE-PHASE MOTORS

Order No. by Voltage			HP	Length in. (mm)	Weight lb. (kg.)
200V	230V	460V			
M05430	M05432	M05434	½	10.8 (275)	22 (9.7)
M07430	M07432	M07434	¾	10.8 (275)	22 (9.7)
M10430	M10432	M10434	1	11.7 (297)	23 (10.4)
M15430	M15432	M15434	1.5	11.7 (297)	23 (10.4)
M20430	M20432	M20434	2	13.8 (351)	28 (12.7)
M30430	M30432	M30434	3	15.3 (389)	32 (14.5)
M50430	M50432	M50434	5	21.7 (550)	55 (24.9)
M75430	M75432	M75434	7.5	27.7 (703)	70 (1.8)

Order No.	HP	Volts	Length in. (mm)	Weight lb. (kg.)
M15437	1.5	575	11.7 (297)	23 (10.4)
M20437	2		15.3 (389)	32 (14.5)
M30437	3		15.3 (389)	32 (14.5)
M50437	5		27.7 (703)	70 (31.8)
M75437	7.5		27.7 (703)	70 (31.8)

AGENCY LISTINGS



Pump/Water End and CentriPro Motor - tested to UL778 and CAN 22.2 by CSA International (Canadian Standards Association)



CentriPro Motor - Certified to NSF/ANSI 61, Annex G, Drinking Water System Components 4P49



NSF/ANSI 372 - Drinking Water System Components - Lead Content

CLASS 6853 01 - Low Lead Content Certification Program - Plumbing Products

Model 5GS

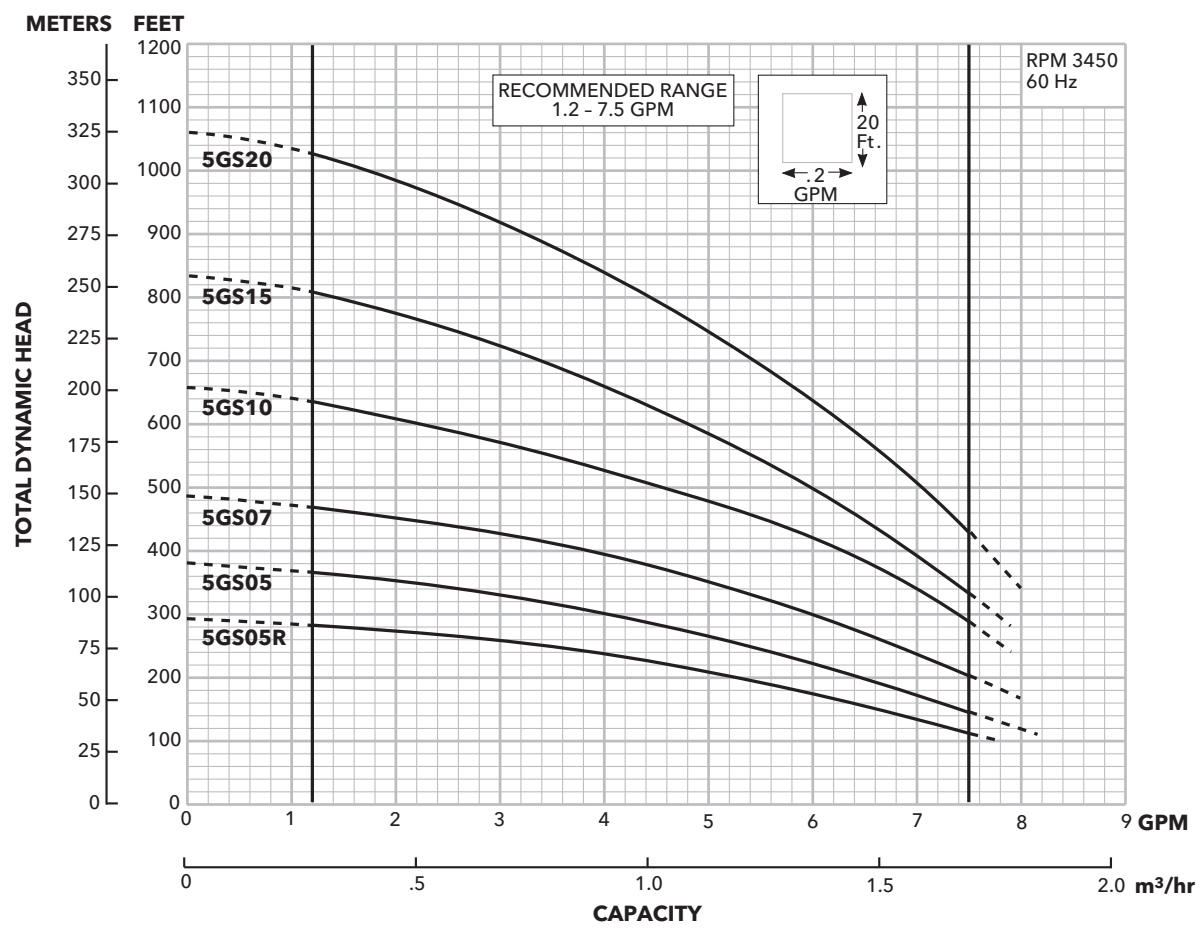

Model 7GS

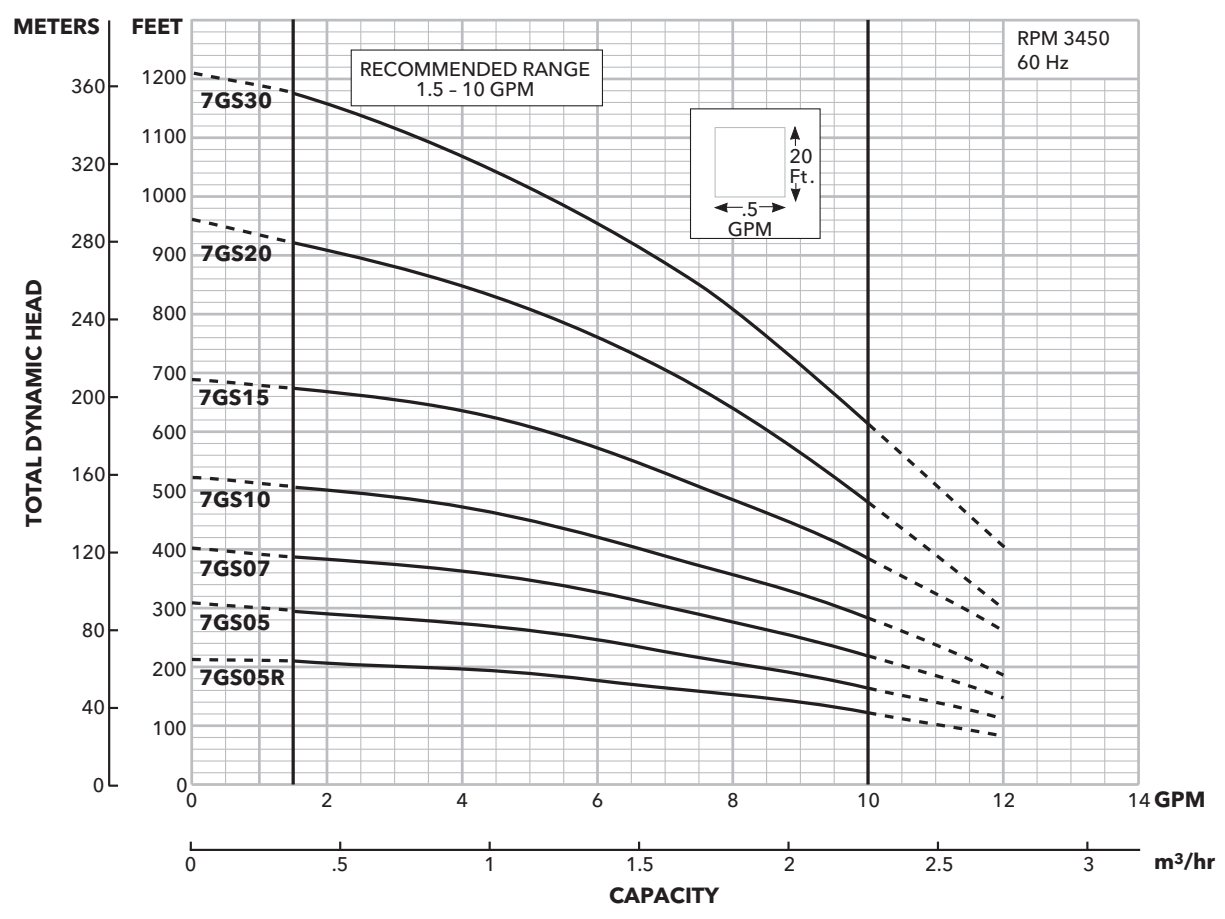

Model 10GS

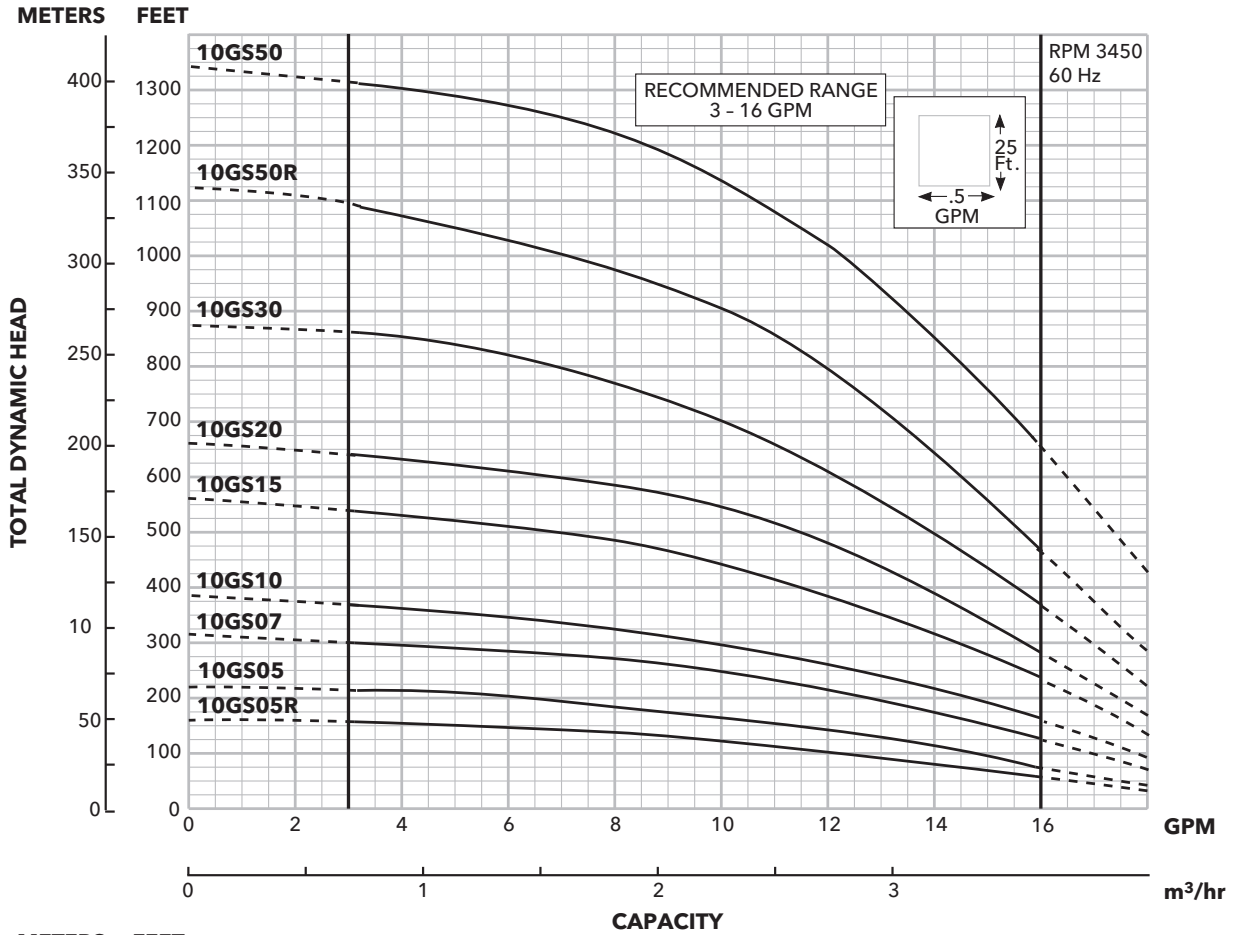

Model 13GS

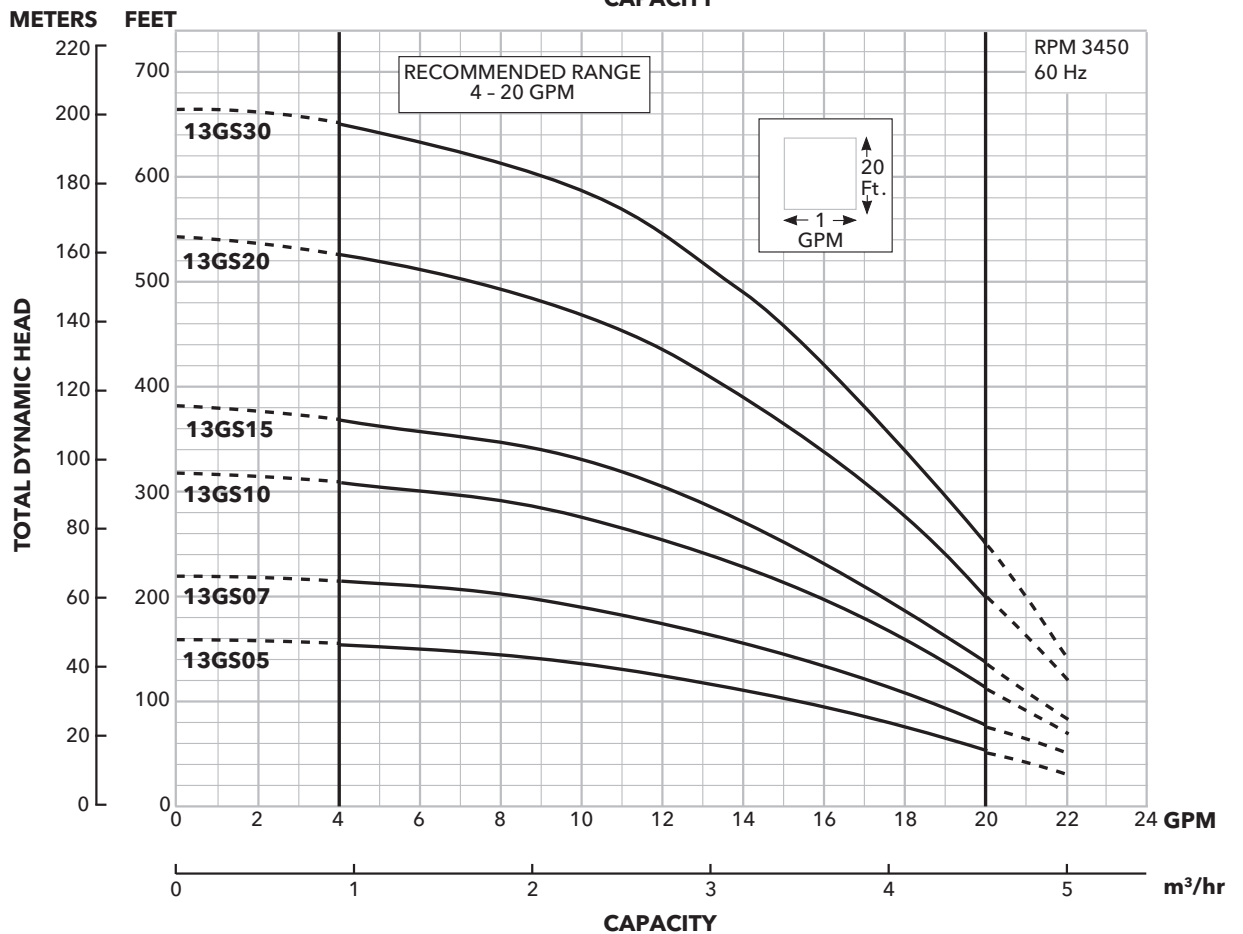

Model 18GS

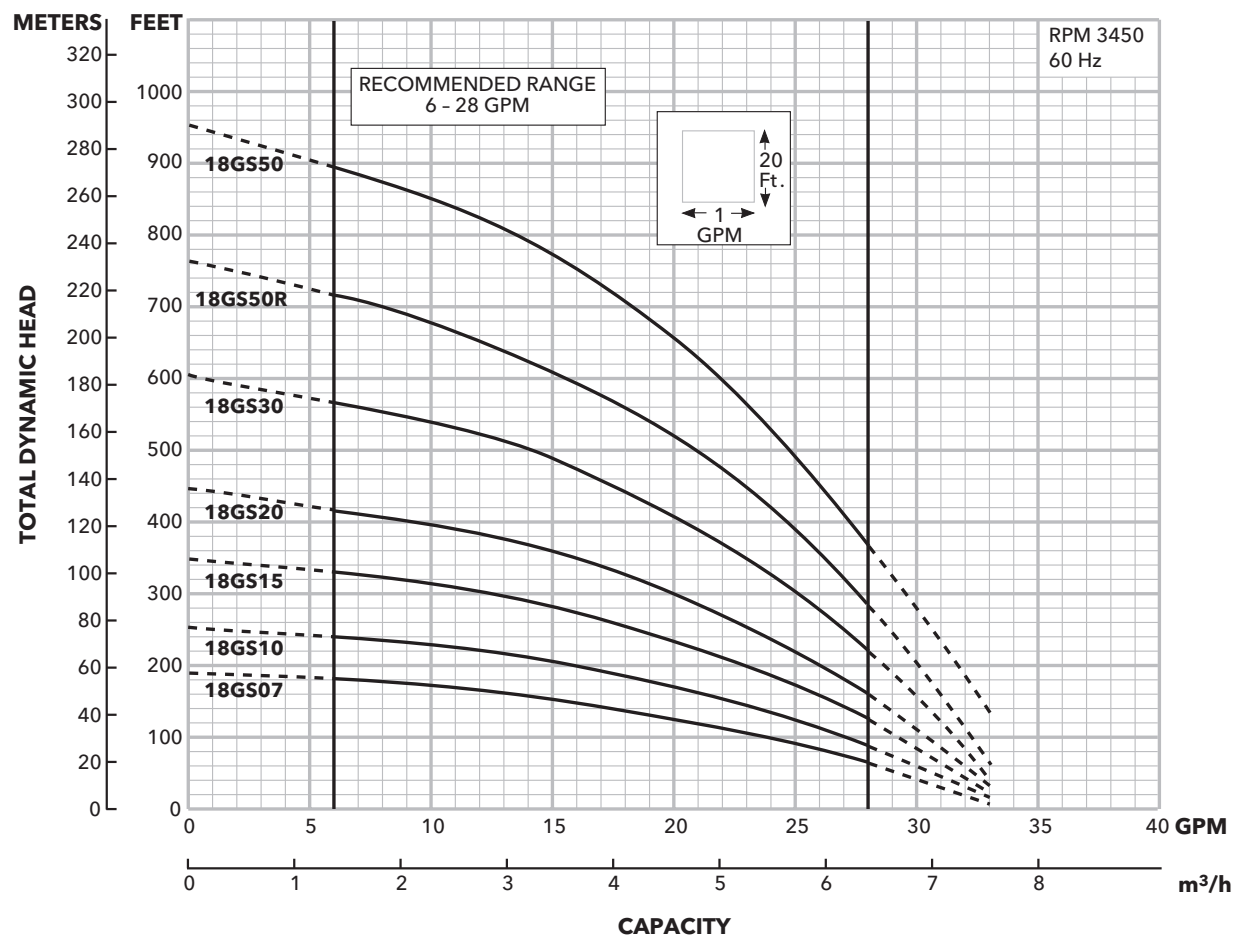

Model 25GS

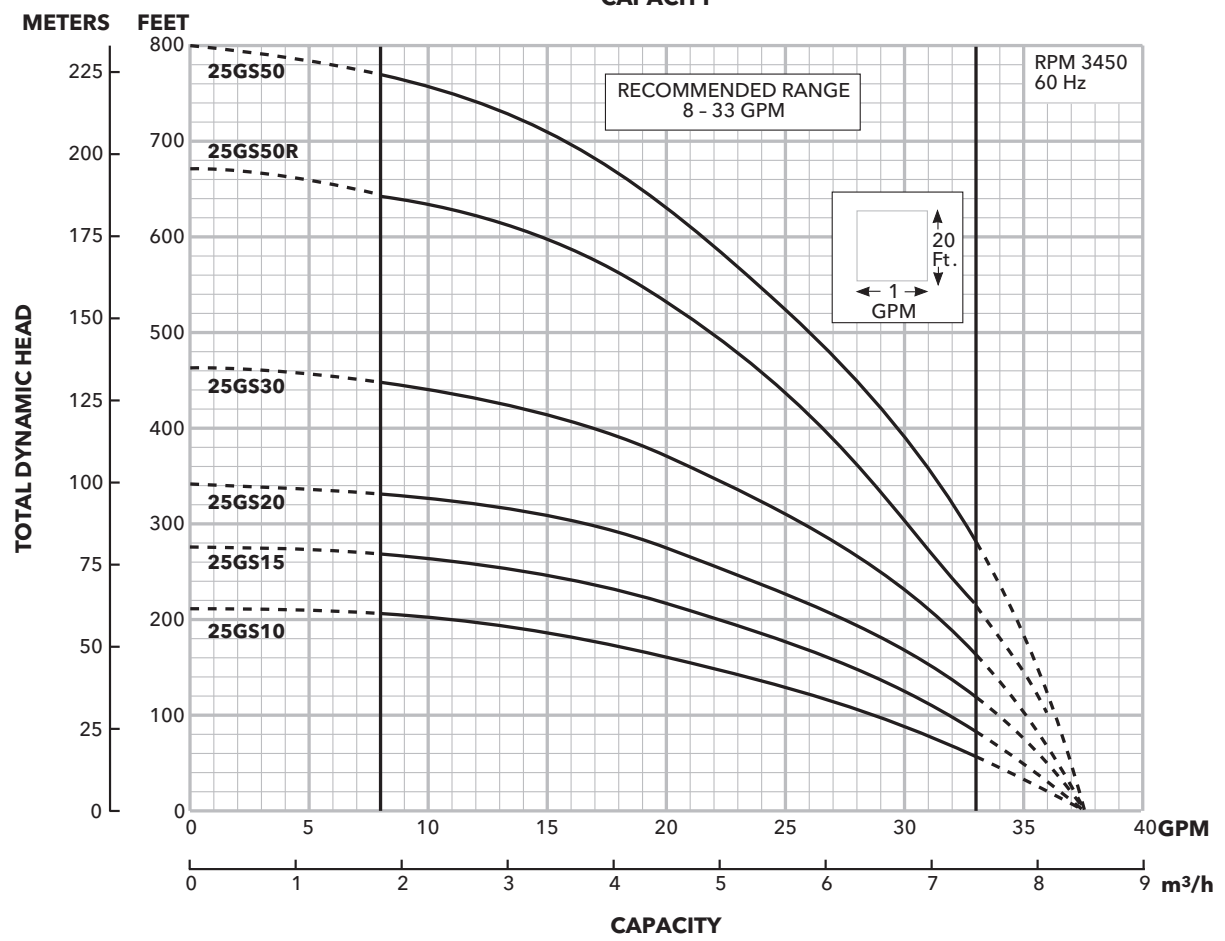

MODEL 7GS

SELECTION CHART

Horsepower Range 1/2 - 1, Recommended Range 1.5 - 10 GPM, 60 Hz, 3450 RPM

Pump Model	HP	PSI	Depth to Water in Feet/Ratings in GPM (Gallons per Minute)																												
			20	40	60	80	100	120	140	160	180	200	220	240	260	280	300	320	340	360	380	400	420	440	460	480	500	540	580	620	
7GS05R	1/2	0						10.2	8.9	7.5	5.9	3.6																			
		20				9.8	8.5	7.0	5.3	2.5																					
		30			9.6	8.3	6.8	4.9	1.9																						
		40		9.4	8.1	6.5	4.6	1.2																							
		50	9.2	7.8	6.3	4.2	0.5																								
		60	7.6	6.0	3.8																										
Shut-off PSI			85	77	68	59	51	42	33	25	16	7																			
7GS05	1/2	0								10.1	9.2	8.3	7.4	6.3	5.0	3.4															
		20						9.8	9.0	8.1	7.1	6.0	4.6	2.7																	
		30					9.7	8.8	7.9	6.9	5.8	4.3	2.4																		
		40			10.4	9.6	8.7	7.8	6.7	5.6	4.1	2.0																			
		50		10.3	9.4	8.5	7.6	6.6	5.4	3.8	1.7																				
		60	10.2	9.3	8.4	7.5	6.4	5.1	3.5																						
Shut-off PSI			125	116	107	99	90	81	73	64	55	47	38	29	21	12															
7GS07	3/4	0											10.0	9.3	8.6	7.9	7.1	6.2	5.2	4.0	2.4										
		20								10.4	9.8	9.1	8.4	7.7	6.9	6.0	4.9	3.5	1.8												
		30						10.3	9.7	9.0	8.3	7.5	6.7	5.8	4.7	3.3	1.5														
		40					10.2	9.5	8.9	8.2	7.4	6.6	5.6	4.5	3.1																
		50				10.1	9.4	8.8	8.1	7.3	6.5	5.5	4.3	2.8																	
		60			10.0	9.3	8.7	7.9	7.2	6.3	5.3	4.1	2.5																		
Shut-off PSI					140	131	122	114	105	96	88	79	70	62	53	44	36	27	18	10											
7GS10	1	0												10.1	9.6	9.0	8.5	7.9	7.3	6.7	6.0	5.3	4.4	3.4	2.1						
		20											10.4	9.9	9.4	8.9	8.3	7.7	7.1	6.5	5.8	5.0	4.1	3.0	1.6						
		30										10.3	9.9	9.3	8.8	8.2	7.6	7.0	6.4	5.7	4.9	4.0	2.8								
		40									10.3	9.8	9.2	8.7	8.1	7.5	6.9	6.3	5.6	4.8	3.8	2.6									
		50									10.2	9.7	9.2	8.6	8.0	7.4	6.8	6.2	5.4	4.6	3.7	2.4									
		60								10.1	9.6	9.1	8.5	7.9	7.3	6.7	6.0	5.3	4.5	3.5	2.2										
Shut-off PSI								166	158	149	140	132	123	114	106	97	88	80	71	62	54	45	36	28	19	10					

Horsepower Range 1 1/2 - 3, Recommended Range 1.5 - 10 GPM, 60 Hz, 3450 RPM

Pump Model	HP	PSI	Depth to Water in Feet/Ratings in GPM (Gallons per Minute)																											
			200	220	240	260	280	300	340	380	420	460	500	540	580	620	660	700	740	780	820	860	900	940	980	1020	1060	1100	1140	
7GS15	1 1/2	0									10.2	9.3	8.5	7.6	6.8	5.9	4.7	2.6												
		20							10.1	9.2	8.3	7.5	6.7	5.8	4.5	2.1														
		30						10.4	9.6	8.7	7.8	7.0	6.2	5.1	3.3															
		40				10.3	9.9	9.1	8.2	7.4	6.6	5.6	4.2	1.6																
		50			10.3	9.9	9.4	8.6	7.7	6.9	6.0	4.9	2.9																	
		60		10.2	9.8	9.4	8.9	8.1	7.2	6.4	5.4	3.9																		
Shut-off PSI				194	186	177	168	151	134	116	99	82	64	47	30	12														
7GS20	2	0											9.8	9.3	8.7	8.4	7.8	7.1	6.3	5.4	4.5	3.5	2.2							
		20											9.8	9.3	8.7	8.4	7.7	6.9	6.2	5.3	4.3	3.2	2.8							
		30										9.9	9.5	9.0	8.5	7.9	7.2	6.4	5.7	4.4	3.7									
		40								10.0	9.7	9.2	8.7	8.3	7.5	6.7	6.0	5.2	4.1	3.0										
		50								9.9	9.4	8.9	8.5	7.8	7.2	6.3	5.5	4.7	3.5											
		60							10.0	9.6	9.1	8.7	8.2	7.4	6.6	5.8	5.0	4.0												
Shut-off PSI								268	251	234	216	199	182	165	147	130	113	95	80	61	43	26								
7GS30	3	0												9.8	9.5	9.2	8.7	8.3	7.9	7.4	6.8	6.2	5.4	4.7	3.9	3.0	2.0			
		20												9.8	9.4	9.2	8.7	8.3	7.8	7.2	6.7	6.2	5.3	4.5	3.7	3.3	1.7			
		30												10.0	9.6	9.2	8.8	8.5	8.0	7.5	6.9	6.3	5.7	4.8	4.1	3.2	2.3			
		40												10.0	9.7	9.4	9.0	8.6	8.2	7.7	7.2	6.6	5.9	5.2	4.4	3.6	2.7	1.7		
		50												9.9	9.5	9.2	8.7	8.4	7.9	7.4	6.8	6.3	5.5	4.8	3.9	3.1	2.2			
		60												10.0	9.7	9.3	9.0	8.6	8.1	7.6	7.0	6.5	5.8	5.1	4.2	3.4	2.5	1.5		
Shut-off PSI												320	303	286	268	251	234	216	199	182	165	147	130	113	95	78	61	43	27	

Residential Water Systems

MODEL 10GS

SELECTION CHART Horsepower Range 1/2 - 3, Recommended Range 3 - 16 GPM, 60 Hz, 3450 RPM

Pump Model	HP	PSI	Depth to Water in Feet/Ratings in GPM (Gallons per Minute)																																				
			20	40	60	80	100	120	140	160	180	200	220	240	260	280	300	340	380	420	460	500	540	580	620	660	700	740	780	820									
10GS05R	1/2	0			15.6	14.0	12.4	10.4	6.5																														
		20	15.4	13.5	11.5	9.2	6.0																																
		30	13.0	11.1	8.0	4.0																																	
		40	11.0	7.9	3.0																																		
		50	7.0																																				
		60																																					
Shut-off PSI			61	53	44	34	26	18	10																														
10GS05	1/2	0				16.0	15.3	14.3	12.8	11.3	9.0	6.4																											
		20		15.9	14.9	13.8	12.5	10.8	8.3	4.8																													
		30	15.7	14.6	13.5	12.3	10.5	7.8	4.0																														
		40	14.5	13.4	12.0	10.3	7.5	3.0																															
		50	13.0	11.5	9.8	7.2																																	
		60	11.3	9.0	6.4																																		
Shut-off PSI			89	81	72	63	55	46	37	29	20	11																											
10GS07	3/4	0					16.0	15.2	14.3	13.4	12.5	11.5	10.3	9.0	7.0	4.0																							
		20				15.8	15.0	14.0	13.0	12.3	11.2	10.2	8.5	6.0																									
		30			15.7	14.8	13.9	12.8	12.0	11.0	9.8	8.2	5.5																										
		40		15.6	14.7	13.8	12.7	11.9	10.8	9.7	8.1	5.2																											
		50	15.3	14.4	13.5	12.6	11.6	10.5	9.4	7.5	4.8																												
		60	14.3	13.4	12.5	11.5	10.3	9.0	7.0	4.0																													
Shut-off PSI			130	121	113	104	95	87	78	69	61	52	43	35	26	17	9																						
10GS10	1	0								15.8	15.2	14.5	13.7	12.8	12.0	11.0	10.0	6.7																					
		20					15.7	14.9	14.3	13.5	12.7	11.7	10.6	9.6	8.1	6.5																							
		30				16.0	15.6	14.8	14.2	13.3	12.5	11.6	10.4	9.4	7.8	5.5	3.0																						
		40			16.0	15.5	14.7	14.1	13.2	12.4	11.5	10.3	9.1	7.4	5.0	3.0																							
		50			15.3	14.6	13.9	13.0	12.3	11.3	10.1	8.9	7.0	4.3																									
		60	15.8	15.2	14.5	13.7	12.8	12.0	11.0	10.0	8.6	6.7	4.0																										
Shut-off PSI			158	150	141	132	124	115	106	98	89	81	72	63	55	46	37	20																					
10GS15	1 1/2	0												15.7	15.3	14.8	14.4	13.3	12.2	10.9	9.3	7.1	3.0																
		20												16.0	15.6	15.2	14.7	14.3	13.7	13.2	11.9	10.6	9.0	6.5															
		30									15.9	15.5	15.2	14.6	14.2	13.5	13.1	12.6	11.3	9.7	7.6	4.0																	
		40							15.8	15.5	15.1	14.6	14.2	13.5	13.0	12.5	11.8	10.3	8.8	6.0																			
		50						15.7	15.4	14.9	14.5	14.0	13.4	12.8	12.3	11.7	11.0	9.4	7.4	3.4																			
		60					15.7	15.3	14.8	14.4	13.9	13.3	12.8	12.2	11.6	10.9	10.1	8.1	5.6																				
Shut-off PSI						197	188	180	171	162	154	144	136	128	119	110	93	76	58	41	24	6																	
10GS20	2	0															16.0	15.7	14.9	14.2	13.4	12.4	11.4	10.0	8.2	5.8													
		20														15.9	15.5	15.3	14.8	14.1	13.2	12.2	11.0	9.9	8.0	5.2													
		30												15.8	15.4	15.1	14.7	14.4	14.0	13.5	12.7	11.7	10.3	8.8	6.5														
		40												15.8	15.4	15.1	14.7	14.4	14.0	12.9	12.2	10.9	9.5	7.8	3.9														
		50									16.1	15.7	15.3	15.0	14.6	14.2	14.0	13.4	12.5	11.5	10.1	8.5	6.0																
		60								16.0	15.7	15.3	14.9	14.5	14.2	13.8	13.4	12.8	11.8	10.7	9.1	7.2	3.4																
Shut-off PSI									225	216	208	199	190	182	173	164	156	139	121	104	87	69	52	35	17														
10GS30	3	0																	15.8	15.2	14.6	14.0	13.3	12.6	11.9	11.0	10.0	9.0	7.5	5.8									
		20																		15.7	15.1	14.5	13.9	13.2	12.5	11.8	10.9	9.9	8.8	7.2	5.4								
		30																			15.9	15.4	14.8	14.2	13.4	12.8	12.0	11.3	10.3	9.3	8.1	6.2	3.8						
		40																				15.9	15.6	15.0	14.4	13.8	13.1	12.4	11.5	10.8	9.7	8.6	7.1	4.7					
		50																					16.0	15.8	15.6	15.3	14.7	14.1	13.3	12.7	11.9	11.0	10.2	9.1	7.8	6.0	3.0		
		60															16.0	15.8	15.5	15.2	14.8	14.3	13.7	12.9	12.3	11.4	10.6	9.6	8.3	6.8	4.5								
Shut-off PSI																284	275	267	258	249	232	215	197	180	163	145	128	111	94	76	59	42	24						

Horsepower Range 5, Recommended Range 3 - 16 GPM, 60 Hz, 3450 RPM

Pump Model	HP	PSI	Depth to Water in Feet/Ratings in GPM (Gallons per Minute)																																			
			340	380	420	460	500	540	580	620	660	700	740	780	820	860	900	940	980	1020	1060																	
10GS50R	5	0					15.6	15.1	14.6	14.2	13.7	13.3	12.8	12.3	11.7	11.0	10.2	9.2	7.9	6.3	4.3																	
		20				16.0	15.5	15.0	14.6	14.1	13.6	13.2	12.7	12.2	11.6	10.9	10.1	9.0	7.6	6.0	3.9																	
		30				15.7	15.3	14.8	14.3	13.8	13.4	12.9	12.4	11.9	11.2	10.4	9.5	8.2	6.7	4.9																		
		40			16.0	15.5	15.0	14.5	14.0	13.6	13.1	12.6	12.1	11.5	10.8	9.9	8.8	7.4	5.7	3.6																		
		50			15.7	15.2	14.7	14.2	13.8	13.3	12.9	12.4	11.8	11.1	10.3	9.3	8.0	6.5	4.5																			
		60	15.9	15.4	14.9	14.4	14.0	13.5	13.0	12.6	12.0	11.4	10.7	9.7	8.6																							

MODEL 13GS

SELECTION CHART

Horsepower Range ½ - 3, Recommended Range 4 - 20 GPM, 60 Hz, 3450 RPM

Pump Model	HP	PSI	Depth to Water in Feet/Ratings in GPM (Gallons per Minute)																												
			20	40	60	80	100	120	140	160	180	200	220	240	260	280	300	340	380	420	460	500	540	580	620	660	700	740	780	820	
13GS05	½	0			19.0	17.5	15.3	12.5	8.2																						
		20	18.8	16.5	14.5	12.0	8.0																								
		30	16.0	13.4	11.0	4.1																									
		40	13.3	10.6	4.0																										
		50	9.8																												
		60																													
Shut-off PSI			60	52	43	35	26	17	9																						
13GS07	¾	0				19.7	18.5	17.0	15.0	13.2	11.5	8.5																			
		20		19.4	18.0	16.4	14.8	12.9	10.5	6.0																					
		30	18.9	17.5	16.0	14.6	12.5	10.0	5.0																						
		40	17.4	15.9	14.4	12.4	9.7	4.0																							
		50	15.4	13.8	12.0	9.5																									
		60	13.2	11.5	8.5																										
Shut-off PSI			86	78	69	61	52	43	35	26	17	8																			
13GS10	1	0					19.6	18.4	17.6	16.6	15.4	14.1	12.8	11.4	9.5	6.0															
		20			20.0	19.4	18.5	17.2	16.3	15.0	13.8	12.5	11.0	8.5	4.0																
		30		20.0	19.2	18.2	17.1	15.8	14.7	13.6	12.2	10.5	7.5																		
		40	19.9	19.0	18.0	17.0	15.7	14.6	13.5	12.0	10.1	7.3																			
		50	18.8	17.8	16.8	15.5	14.5	13.0	11.6	9.9	7.0																				
		60	17.6	16.6	15.4	14.1	12.8	11.4	9.5	6.0																					
Shut-off PSI			128	119	110	102	93	84	76	67	58	50	41	32	24	15	6														
13GS15	1½	0						19.7	18.9	18.2	17.3	16.3	15.2	14.2	13.2	12.1	8.7														
		20					19.5	18.4	17.9	17.0	16.0	15.1	14.1	12.9	11.8	10.2	8.8														
		30			20.2	19.4	18.6	17.6	16.8	15.8	14.9	14.0	12.6	11.5	9.9	7.9	4.0														
		40		20.0	19.3	18.5	17.5	16.6	15.7	14.8	13.9	12.5	11.4	9.5	7.3	4.0															
		50	20.0	19.1	18.3	17.4	16.4	15.5	14.5	13.6	12.3	11.0	9.2	6.3																	
		60	18.9	18.2	17.3	16.3	15.2	14.2	13.3	12.1	11.0	8.7	5.6																		
Shut-off PSI			156	147	139	130	121	113	104	95	87	78	69	61	52	43	35	17													
13GS20	2	0									20.0	19.5	19.0	18.3	17.9	17.2	15.8	14.4	12.6	10.5	7.7										
		20									19.8	19.4	18.8	18.2	17.6	17.0	16.3	15.6	14.1	12.4	10.2	6.8									
		30									19.7	19.3	18.7	18.2	17.4	16.8	16.2	15.5	14.8	13.1	11.1	8.8									
		40									19.6	19.2	18.6	18.1	17.3	16.7	16.1	15.4	14.7	13.8	12.0	9.8	6.0								
		50										20.1	19.5	19.1	18.4	18.0	17.2	16.6	16.0	15.2	14.6	13.7	12.9	10.8	8.5						
		60			20.0	19.5	19.0	18.3	17.9	17.2	16.5	15.8	15.1	14.4	13.6	12.6	11.5	9.2	5.0												
Shut-off PSI					206	198	189	180	172	163	155	146	137	129	120	111	103	85	68	51	33	16									
13GS30	3	0													19.8	19.4	18.9	18.0	17.1	16.0	14.6	13.5	11.9	10.0	7.3						
		20													19.6	19.2	18.9	18.3	17.9	17.0	15.9	14.7	13.3	11.8	9.7	6.9					
		30														20.0	19.5	19.1	18.8	18.2	17.8	17.4	16.4	15.2	13.9	12.3	10.5	8.3	4.0		
		40														20.0	19.4	19.1	18.7	18.2	17.8	17.3	16.8	15.6	14.5	13.0	11.4	9.5	6.0		
		50														19.9	19.5	19.0	18.6	18.1	17.7	17.2	16.7	16.1	14.9	13.7	12.0	10.1	7.9		
		60														19.8	19.4	18.9	18.5	18.0	17.5	17.1	16.6	16.0	15.4	14.2	12.9	11.0	9.0	5.0	
Shut-off PSI								235	226	217	209	200	191	183	174	165	157	139	122	104	87	70	53	35	18						

MODEL 18GS

SELECTION CHART

Horsepower Range ¾ - 5, Recommended Range 6 - 28 GPM, 60 Hz, 3450 RPM

Pump Model	HP	PSI	Depth to Water in Feet/Ratings in GPM (Gallons per Minute)																														
			20	40	60	80	100	120	140	160	180	200	220	240	260	280	300	340	380	420	460	500	540	580	620	660	700	740	780	820	860		
18GS07	¾	0			28.2	26.5	24.0	21.0	17.9	13.5																							
		20	27.7	25.9	23.0	20.0	16.5	10.8																									
		30	25.0	22.0	18.8	15.7	9.5																										
		40	22.2	18.9	15.1	9.0																											
		50	18.4	15.0	7.5																												
		60	13.5	5.0																													
Shut-off PSI			74	66	58	49	40	32	23	14																							
18GS10	1	0					27.0	25.5	23.6	21.2	18.8	15.9	12.0																				
		20		28.0	26.6	25.1	22.7	20.0	17.6	14.0	10.0																						
		30	27.9	26.1	24.3	22.2	19.8	17.1	13.8	8.3																							
		40	26.0	24.1	22.0	19.7	17.0	13.1	8.0																								
		50	24.0	22.0	19.1	16.5	13.0	7.1																									
		60	21.0	18.6	15.8	12.0																											
Shut-off PSI			103	94	86	77	68	60	51	42	34	25	16																				
18GS15	1½	0					28.4	27.2	26.0	24.8	23.0	21.4	19.6	17.5	15.0	12.1																	
		20				27.8	26.8	25.4	24.0	22.2	20.6	18.8	16.7	14.0	10.0																		
		30			27.7	26.5	25.3	23.8	22.0	20.2	18.5	16.1	13.5	10.0																			
		40		27.5	26.3	25.0	23.6	22.0	20.1	18.1	16.0	13.1	9.5																				
		50	27.6	26.4	25.0	23.4	21.8	20.0	18.0	15.5	13.0	9.2																					
		60	26.0	24.6	23.0	21.2	19.5	17.5	15.0	12.0	7.9																						
Shut-off PSI			143	134	126	117	108	100	91	82	74	65	56	48	39	30	22																
18GS20	2	0							28.0	27.1	26.2	25.1	24.0	22.9	21.4	20.0	16.8	12.8															
		20					27.8	26.8	25.8	24.6	23.7	22.6	21.0	19.5	18.0	16.0	11.6																
		30				27.5	26.5	25.5	24.5	23.3	22.1	20.6	19.0	17.5	15.8	13.6	6.5																
		40		28.5	27.4	26.4	25.4	24.4	23.2	22.0	20.5	18.9	17.4	15.7	13.5	11.0																	
		50	28.0	27.2	26.2	25.3	24.3	23.0	21.8	20.3	18.7	17.0	15.3	13.1	10.5	6.0																	
		60	28.0	27.1	26.2	25.1	24.0	22.9	21.4	20.0	18.3	16.8	14.8	12.8	9.5																		
Shut-off PSI			183	174	165	157	148	139	131	122	113	105	96	87	79	70	61	44	27														
18GS30	3	0										28.0	27.4	26.7	26.0	25.0	23.5	21.5	19.2	16.9	14.2	10.5											
		20									27.7	27.0	26.3	25.8	24.9	24.0	23.0	21.0	18.9	16.5	13.5	9.0											
		30									27.6	26.9	26.2	25.5	24.8	23.9	22.9	21.9	19.8	17.5	14.9	11.2											
		40							27.5	26.9	26.2	25.4	24.6	23.8	22.8	21.8	20.9	18.5	16.0	13.3	8.0												
		50						27.4	26.8	26.0	25.2	24.5	23.6	22.6	21.7	20.6	19.5	17.3	14.5	11.0													
		60				28.0	27.4	26.7	26.0	25.0	24.3	23.5	22.5	21.5	20.5	19.2	18.0	15.7	12.8	7.0													
Shut-off PSI					225	216	208	199	190	182	173	164	156	147	139	130	113	95	78	61	43	26											
18GS50R	5	0														27.7	26.6	25.4	24.0	22.5	20.8	19.0	16.9	14.5	11.7	8.1							
		20														27.6	27.0	26.4	25.2	23.8	22.2	20.5	18.7	16.6	14.1	11.2	7.4						
		30													28.0	27.5	26.9	26.3	25.7	24.4	22.9	21.3	19.5	17.5	15.2	12.5	9.1						
		40											27.9	27.4	26.8	26.2	25.6	25.0	23.5	22.0	20.3	18.4	16.2	13.7	10.6	6.7							
		50										27.9	27.3	26.7	26.1	25.5	24.8	24.1	22.7	21.0	19.2	17.2	14.8	12.0	8.5								
		60									27.8	27.2	26.7	26.1	25.4	24.7	24.0	23.3	21.7	20.0	18.1	15.9	13.3	10.1	6.0								
Shut-off PSI									261	252	244	235	226	218	209	200	183	166	148	131	114	96	79	62	44	27							
18GS50	5	0																27.9	26.8	25.8	24.8	23.7	22.6	21.2	19.9	18.4	16.8	14.8	12.4	9.7			
		20																	27.5	26.6	25.6	24.5	23.3	22.2	21.0	19.8	18.0	16.2	14.3	12.0	8.8		
		30																	28.0	26.9	26.0	25.0	23.9	22.9	21.6	20.3	18.6	17.0	15.0	13.0	10.2	6.2	
		40																28.0	27.4	26.3	25.3	24.4	23.2	22.1	20.1	19.4	17.9	16.0	14.0	11.6	8.0		
		50															27.9	27.3	26.8	25.9	24.9	23.8	22.7	21.3	20.1	18.5	16.9	14.9	12.8	10.0	6.0		
		60															27.9	27.2	26.8	26.2	25.2	24.1	23.0	21.9	20.7	19.2	17.5	15.8	13.6	11.0	7.8		
Shut-off PSI																307	298	290	281	264	246	229	212	195	177	160	143	125	108	91	73	56	39

MODEL 25GS

SELECTION CHART

Horsepower Range 1 - 5, Recommended Range 8 - 33 GPM, 60 Hz, 3450 RPM

Pump Model	HP	PSI	Depth to Water in Feet/Ratings in GPM (Gallons per Minute)																										
			20	40	60	80	100	120	140	160	180	200	220	240	260	280	300	340	380	420	460	500	540	580	620	660	700	740	
25GS10	1	0			32.8	30.8	28.6	26.2	23.5	20.0	16.2	11.0																	
		20	31.8	30.0	27.5	25.2	22.0	19.0	15.0	8.0																			
		30	29.6	27.2	25.0	21.6	18.0	14.0																					
		40	27.1	24.9	21.5	17.9	13.9																						
		50	24.3	21.0	17.5	13.0																							
		60	20.0	16.2	11.0																								
Shut-off PSI			82	74	65	56	48	39	30	22	13	4																	
25GS15	1½	0				33.0	31.8	30.3	28.8	26.9	24.8	22.0	19.8	16.5	11.0														
		20		32.6	31.2	29.6	28.0	26.0	23.8	21.0	18.1	14.8	8.0																
		30	32.5	31.0	29.5	27.6	25.6	23.2	20.9	17.9	14.0																		
		40	30.9	29.4	27.5	25.5	23.1	20.8	17.7	13.6																			
		50	29.0	27.2	25.1	22.9	20.4	17.2	13.0																				
		60	26.9	24.8	22.0	19.8	16.5	11.0																					
Shut-off PSI			111	103	94	85	77	68	59	51	42	33	25	16	7														
25GS20	2	0					33.0	31.8	30.4	29.0	27.4	25.7	22.6	21.5	19.3	15.4													
		20				32.7	31.3	30.0	28.6	26.8	25.0	22.9	20.9	18.3	14.3	9.0													
		30			32.3	31.0	29.6	28.5	26.4	24.5	22.6	20.5	18.0	14.0	8.0														
		40			30.9	29.5	28.2	26.3	24.3	22.4	20.4	17.8	13.6	8.0															
		50		30.5	29.4	28.0	26.0	24.1	22.1	20.0	17.2	13.2																	
		60	30.4	29.0	27.4	25.7	22.6	21.5	19.3	15.4	12.2																		
Shut-off PSI			139	130	121	113	104	95	87	78	69	61	52	43	35	26	17												
25GS30	3	0							33.0	32.2	31.5	30.5	29.6	28.3	27.1	25.8	22.6	19.0	14.0										
		20						32.8	32.0	31.0	30.0	29.0	27.9	26.6	25.0	23.8	21.9	20.0	12.6										
		30					32.6	31.8	30.9	30.0	28.8	27.6	26.5	24.9	23.4	21.6	19.9	15.2	8.0										
		40				32.5	31.7	30.9	29.9	28.8	27.5	26.2	24.7	23.3	21.5	19.9	17.8	11.9											
		50			32.3	31.6	30.8	29.8	28.5	27.3	26.0	24.5	23.0	21.2	19.5	17.4	11.5												
		60	33.0	32.2	31.5	30.5	29.6	28.3	27.1	25.8	24.1	22.6	20.9	19.0	16.9	14.0	10.0												
Shut-off PSI			191	183	174	165	157	148	139	131	122	113	105	96	87	79	70	53	35	18									
25GS50R	5	0											32.7	32.2	31.7	31.2	30.5	29.1	27.3	25.3	23.3	21.4	19.3	16.5	11.7				
		20										33.0	32.5	32.1	31.5	31.0	30.3	29.6	28.8	27.0	25.0	23.0	21.1	18.9	15.9	10.6			
		30							32.9	32.5	32.0	31.5	30.9	30.2	29.5	28.7	27.8	25.9	23.9	21.9	19.9	17.4	13.3						
		40						32.9	32.4	31.9	31.4	30.8	30.1	29.4	28.5	27.6	26.7	24.7	22.7	20.8	18.6	15.3							
		50					32.8	32.3	31.8	31.3	30.7	30.0	29.2	28.4	27.5	26.5	25.6	23.6	21.6	19.6	16.9								
		60				32.7	32.2	31.7	31.2	30.6	29.9	29.1	28.3	27.4	26.4	25.4	24.4	22.4	20.4	18.2	14.6								
Shut-off PSI						252	243	234	226	217	208	200	191	182	174	165	156	139	122	104	87	70	52	35	18				
25GS50	5	0													33.0	32.5	31.5	30.2	29.0	27.6	26.0	24.2	22.4	20.5	18.3	15.8	12.0		
		20													32.9	32.3	31.8	31.3	30.0	28.8	27.2	25.8	23.9	22.0	20.0	17.8	15.0	11.0	
		30													32.8	32.2	31.8	31.2	30.5	29.3	27.9	26.4	24.8	22.9	21.0	18.9	16.2	13.0	8.0
		40												32.7	32.1	31.7	31.1	30.4	29.9	28.5	27.1	25.4	23.7	21.9	19.9	17.5	14.5	10.5	
		50											32.6	32.1	31.6	31.0	30.3	29.9	29.2	27.8	26.3	24.5	22.6	21.8	18.7	16.0	12.7		
		60							33.0	32.5	32.0	31.5	30.8	30.2	29.8	29.0	28.3	26.9	25.1	23.3	21.5	19.5	17.0	14.0	9.5				
Shut-off PSI								286	277	268	260	251	242	234	225	216	199	182	165	147	130	113	95	78	61	43	26		



Xylem Inc.
 2881 East Bayard Street Ext., Suite A
 Seneca Falls, NY 13148
 Phone: (866) 325-4210
 Fax: (888) 322-5877
www.gouldswatertechnology.com

Goulds is a registered trademark of Goulds Pumps, Inc. and is used under license.
 CentriPro is a trademark of Xylem Inc. or one of its subsidiaries.
 Noryl and Lexan are trademarks of GE Plastic.
 © 2014 Xylem Inc. B5-25GS R4 November 2014